



▲ Model 8101 shown w/ 812 pilot

While similar to the Series 8000 On/Off Float Valves through the use of a rotary disc float control, the 8100 series provides modulating rather than on/off type action. In this way, level in the vessel can be continuously maintained within extremely narrow limits.

SERIES FEATURES

- ▶ Can control level by flow-in or flow-out of tank.
- ▶ Single control line from valve to pilot (water service).
- ▶ Three pilot types available.
- ▶ Accurate constant level control.
- ▶ Positive shut-off on high level.
- ▶ Valve mounting can be top fill or bottom fill.

VALVE FEATURES

- ▶ Operates automatically off line pressure.
- ▶ Heavy-duty, nylon-reinforced diaphragm.
- ▶ Rectangular-shaped, soft seat seal provides drip-tight Class VI closure.
- ▶ Diaphragm assembly guided top and bottom.
- ▶ Throttling seat retainer for flow and pressure stability.
- ▶ Easily maintained without removal from the line.
- ▶ Replaceable seat ring.
- ▶ Alignment pins assure proper reassembly after maintenance.
- ▶ Valves are factory tested.
- ▶ Valves are serial numbered and registered to facilitate replacement parts and factory support.

TANK FILL VALVE

Opens on falling level and closes on rising level. (shown with 813 pilot)
Mounting of valve and pilot provides an air gap between pilot and liquid level.

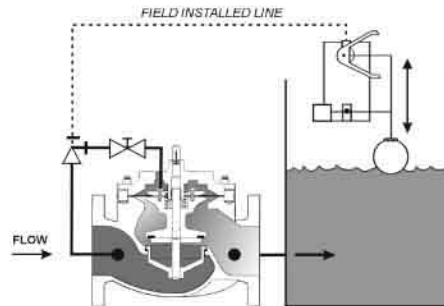

TANK DISCHARGE VALVE

Opens on rising level and closes on falling level. (shown with 812 pilot)

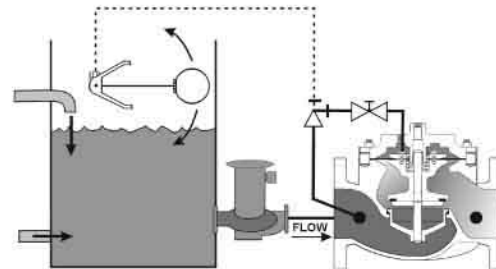

TANK FILL VALVE

Opens on falling level and closes on rising level. (shown with chamber mounted 815 pilot)
Typical for fuel service, floating pan tanks.

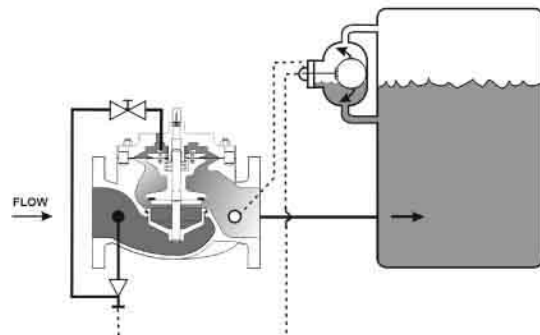

VALVE OPERATION

TANK FILL OPERATION (MODEL 8102)

A single sense line connects the pilot (mounted above the liquid level) to the ejector on the main valve. Through the ejector, inlet pressure on the valve is supplied to the valve's upper control chamber (bonnet) and to the pilot valve. As the level changes the pilot responds by either discharging pressure off the bonnet of the main valve thereby allowing the valve to open (falling level), or diverting inlet pressure to the bonnet, causing it to close (rising level). Level is maintained.

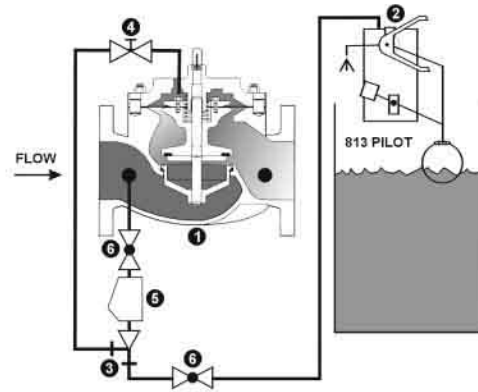

ITEM	DESCRIPTION
1	BASIC VALVE ASSEMBLY
2	TWO-WAY FLOAT PILOT
3	EJECTOR
4	NEEDLE VALVE
5	Y-STRAINER
6	ISOLATION BALL VALVE

TANK DISCHARGE OPERATION (MODEL 8111)

The float pilot (mounted at the liquid level) is connected to the ejector on the main valve which is installed on the tank discharge line. Through the ejector, inlet pressure on the valve is supplied to the valve's upper control chamber (bonnet) and to the pilot valve. In this application the float pilot is reverse acting. As the level changes the pilot responds by either discharging pressure off the bonnet of the main valve thereby allowing the valve to open (rising level), or diverting inlet pressure to the bonnet, causing it to close (falling level). Level is maintained.

It is important to note that this application requires the use of a pump between the tank and the valve. For gravity applications the configuration of the valve will change.

Note: In either tank fill or tank discharge, valve sizes up to 6" are controlled directly by the rotary float pilot as shown here. For valve sizes 8" and larger, the float pilot operates a Model 1356 relay pilot which, in turn, operates the main valve.

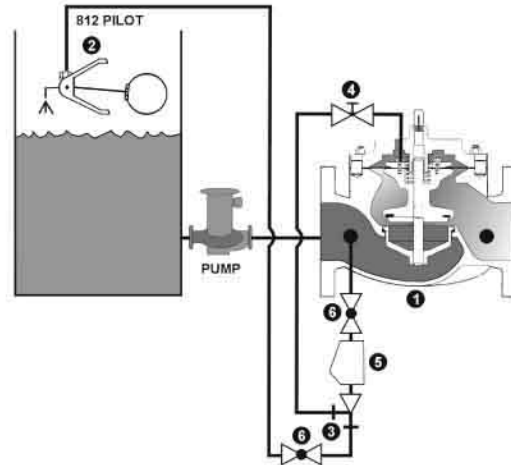

HYDRAULIC REQUIREMENTS

For proper operation of bottom fill valves, and especially tank discharge valves, inlet pressure should be at least 5 psi greater than that of tank head. In brief, without the minimum 5 psi differential, the valve will not work. Lack of such minimum should not eliminate the valve from consideration. Refer to the Series 8100 Valve Selection Guide in this Tech Series for model numbers

INSTALLATION

After the main valve is installed the pilot sense line must be connected to the float pilot. The proper installation of the pilot line is critical to the efficient operation of the float valve. Minimum recommended size for the sense line is 1/2" OD tubing or 3/8" pipe. The pilot supply port is 3/8" NPT.

In any float pilot installation where there is periodic or continuous turbulence within the tank, consideration must be given to shielding the float from such turbulence with a stilling well. Failure to do so can result in erratic valve control

PILOTS 812, 813, 815

► It should be understood that there is essentially no difference in the operation of the three rotary pilots used in the 8100 series. Only in a few physical characteristics do they vary.

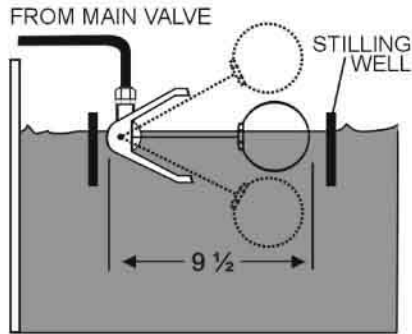

Pilot Model 812

Of the three rotary float pilots, the non-adjustable 812 is the simplest. Connected to the main valve by a sense line 3/8" NPT or larger, the 812 can be installed in the tank simply by suspending it from this line. Although the pilot is primarily designed for modulation, if high-level shutoff is desired, the 812 can be set to throttle the valve closed over the last few inches of level change. Liquid off the bonnet of the main valve is discharged by the pilot directly into the tank. The 812 is suitable for both water and fuel service, although it does not lend itself to installation in floating roof tanks.

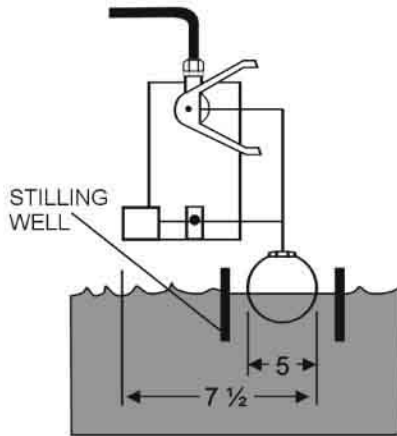

Pilot Model 813

The 813 rotary float pilot operates identically to the 812 described above, but, in addition, is equipped with an adjustable float and is constructed to provide an air gap between the float and pilot. The float assembly allows the operator to make appropriate changes in float position to accommodate specific operating conditions. The air gap feature prevents cross-connection. The (adjustable length) float arm of the 813 is counterweight-balanced for free and effortless movement.

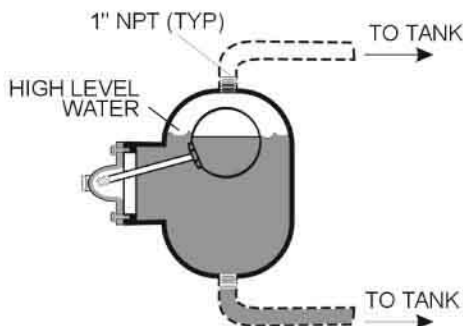

Pilot Model 815 (Chamber-Mounted Pilot)

Used primarily for fuel installations, the non-adjustable 815 rotary float pilot is specifically designed for floating roof tanks or similar installations where access to the interior of the vessel is inconvenient or impossible. The 815 installs on the exterior of the tank and, once in place, operates identically to the 812. Liquid off the bonnet of the main valve is vented back into the chamber, or, if desired, back to the outlet of the main valve.

SIZING CONSIDERATIONS

While most Series 8100 valves are line sized, there are two factors that should be checked. Maximum flow rate should not exceed 25 ft/sec, in other words don't use too small a valve. At the same time, you don't want the valve so large that when it opens, it drops the system pressure so low that there is not enough pressure to close the valve when high level is reached. Our ValveMaster selection and sizing software covers this in detail. However, if you do not have the software, sizing within the flow limitations shown in the following table should result in satisfactory operation.

SIZE	1 1/4"	1 1/2"	2"	2 1/2"	3"	4"	6"	8"	10"	12"	14"	16"	24"
Min. flow, gpm	14	23	50	75	115	200	450	780	1225	1750	2100	2750	6250
Max. flow, gpm	115	160	260	370	570	1000	2250	3900	6150	8700	10,500	13,800	31,300

TOLL FREE 1.888.628.8258 • phone: (918)627.1942 • fax: (918)622.8916 • 7400 East 42nd Place, Tulsa, Oklahoma 74145
email: sales@controlvalves.com • website: www.controlvalves.com

Global performance. Personal touch.

VALVE SELECTION GUIDE

By combining various control pilots, multiple valve functions can be performed on a single Series 8100 Float Control Valve. To find the combination function valve, select the desired features and then the model number.

This chart shows only a sample of those most often specified valves. Consult the factory for specific data on the model you selected.

Feature	8101	8102	8103	8104	8105	8106	8111	8112	8113	8114	8115	8116	8121	8122	8131	8132	81xx-1*	81xx-2*	81xx-6*	Definition
Flow Into Tank	X	X	X	X	X	X							X	X						Controls flow into the tank
Flow Out Of Tank							X	X	X	X	X	X			X	X				Controls flow out of the tank
812 Float Pilot	X			X			X			X			X		X					Modulating float pilot with horizontal pivot
813 Float Pilot		X			X			X			X			X		X				Modulating float pilot with vertical rod, adjustable
815 Float Pilot			X			X		X				X								External chamber w/ modulating pilot inside
1356 Relay Pilot				X	X	X				X	X	X								Auxiliary Control for use on valve sizes 8" and larger
Check Feature																			X	Closes valve on pressure reversal
Solenoid Override (Energize to Open)																	X			Opens valve electrically
Solenoid Override (Energize to Close)																		X		Closes valve electrically
Power Actuated Main Valve w/ independent press.													X	X	X	X				For gravity flow and other low differential

* can be applied to any of the listed models

ABOUT YOUR VALVE

OCV Control Valves was founded more than 50 years ago with a vision and commitment to quality and reliability. From modest beginnings, the company has grown to be a global leader just a half century later. In fact, OCV Valves can be found in some capacity in nearly every country around the world from fire protection systems in Malaysia to aircraft fueling systems in Africa and from oil refineries in Russia to water supply systems in the USA and Canada. You will also find our valves in irrigation systems in Europe, South America and the Middle East.

The original foundation on which the company was built allows our team of professionals to not only provide the service required to be a worldwide supplier, but more importantly the opportunity to afford the personal touch necessary to be each of our customers' best partner. Simply stated, we take pride in all that we do.

Committed to the work they do, our employees average over 15 years of service. This wealth of knowledge allows us to provide quality engineering, expert support, exacting control and the know-how to create valves known for their long life.

Being ISO 9001 certified means we are committed to a quality assurance program. Our policy is to supply each customer with consistent quality products and ensure that the process is right every time. Our valves meet and exceed industry standards around the world, including approvals by:



All valves are not created equal. OCV Control Valves proves that day in and day out. We stand behind our valves and are ready to serve your needs.

TOLL FREE 1.888.628.8258 • phone: (918)627.1942 • fax: (918)622.8916 • 7400 East 42nd Place, Tulsa, OK 74145
email: sales@controlvalves.com • website: www.controlvalves.com

Global performance. Personal touch.

SPECIFICATIONS

VALVE BODY & BONNET	DUCTILE IRON		CAST STEEL		CAST BRONZE		STAINLESS STEEL	
Material Specifications	ASTM A536 (epoxy coated)		ASTM A216/WCB (epoxy coated)		ASTM B61		ASTM A743/CF8M	
END CONNECTIONS								
Flange Standard (also available in metric)	ANSI B16.42		ANSI B16.5		ANSI B16.24		ANSI B16.5	
Flange Class	150#	300#	150#	300#	150#	300#	150#	300#
Flange Face	Flat	Raised	Raised	Raised	Flat	Flat	Raised	Raised
Maximum Working Pressure	250 psi	640 psi	285 psi	740 psi	225 psi	500 psi	285 psi	740 psi
Screwed Working Pressure:	ANSI B1.20.1 (B2.1) 640 psi (Bronze 500 psi)				Grooved End Working Pressure: 300 psi			
INTERNALS								
Stem	STAINLESS STEEL AISI 303				OPTIONAL MONEL			
Spring	STAINLESS STEEL AISI 302							
Spool	DUCTILE IRON ASTM A536 (epoxy coated)				B-61		STN. STL. ASTM A 743/CF8M	
Seat Disc Retainer	DUCTILE IRON ASTM A536 (epoxy coated) 4" & SMALLER VALVES - STAINLESS STEEL				B-61		STAINLESS STEEL	
Diaphragm Plate	DUCTILE IRON ASTM A536 (epoxy coated)				B-61		STAINLESS STEEL	
Seat Ring (Trim)	BRONZE B61 OPTIONAL STAINLESS STEEL ASTM A743/CF8M						STN. STL. ASTM A 743/CF8M	
Upper Stem Bushing	STANDARD BRONZE ASTM B438		VALVE W/ STAINLESS STEEL SEAT RING-TEFLON			TEFLON		
Lower Stem Bushing	SEAT MATERIAL VALVES W/ STAINLESS STEEL SEAT RING-TEFLON						TEFLON	
ELASTOMER PARTS (Rubber)								
Diaphragm/Seat Disc/O-Rings	STANDARD - BUNA-N NYLON REINFORCED				OPTIONAL - VITON®		OPTIONAL - EPDM	
Operating Temperature	-40°F to 180°F				32°F to 400°F		0°F to 300°F	
COATINGS WIDE RANGE OF COATING PER YOUR FLUID APPLICATION. COATINGS HANDLE MUNICIPAL POTABLE WATER, SEAWATER, PETROLEUM AND REFINED PRODUCTS.								
ELECTRICAL SOLENOIDS								
Bodies	STANDARD BRASS				STAINLESS STEEL (OPTIONAL)			
Elastomers	STANDARD - BUNA-N NYLON REINFORCED				OPTIONAL - VITON®			
Enclosures	WATER TIGHT, NEMA 1, 3, 4, & 4X - EXPLOSION PROOF - OPTIONAL (NEMA 7 & 9)							
Power	AC, 60HZ - 24, 120, 240, 480 VOLTS		AC, 50HZ - In 110 VOLT MULTIPLES			DC, 6, 12, 24, 240 VOLTS		
Operation	ENERGIZE TO OPEN (NORMALLY CLOSED)				DE-ENERGIZE TO OPEN (NORMALLY OPEN)			
CONTROL PILOTS								
Bodies	BRONZE B61		STAINLESS STEEL ASTM A743/CF8M					
Internal	AISI 303							
CONTROL CIRCUITS								
Tubing	COPPER OR STAINLESS STEEL							
Fittings	BRASS OR STAINLESS STEEL							

SALTWATER SERVICE VALVE MATERIALS

Cast Steel Special Coatings --Ni Aluminum Bronze ASTM B148 --Super Duplex Stainless Steel



Globe Flanged Sizes

1.25"	1.5"	2"	2.5"	3"	4"	6"	8"	10"	12"	14"	16"	18"	20"	24"
32mm	40mm	50mm	65mm	80mm	100mm	150mm	200mm	250mm	300mm	350mm	400mm	450mm	500mm	600mm



Angle Flanged Sizes

1.25"	1.5"	2"	2.5"	3"	4"	6"	8"	10"	12"	16"
32mm	40mm	50mm	65mm	80mm	100mm	150mm	200mm	250mm	300mm	400mm



Globe/Angle Screwed Sizes

1.25"	1.5"	2"	2.5"	3"
32mm	40mm	50mm	65mm	80mm



Globe/Angle Grooved Sizes

1.5"	2"	2.5"	3"	4"
32mm	50mm	65mm	80mm	100mm

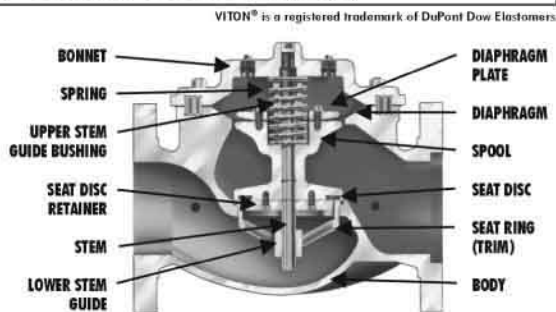

TOLL FREE 1.888.628.8258 • phone: (918)627.1942 • fax: (918)622.8916 • 7400 East 42nd Place, Tulsa, OK 74145
email: sales@controlvalves.com • website: www.controlvalves.com

DIMENSIONS

U.S. DIMENSIONS - INCHES

DIM	END CONN.	1 1/4-1 1/2	2	2 1/2	3	4	6	8	10	12	14	16	24
A	SCREWED	8 3/4	9 7/8	10 1/2	13	--	--	--	--	--	--	--	--
	GROOVED	8 3/4	9 7/8	10 1/2	13	15 1/4	20	--	--	--	--	--	--
	150# FLGD	8 1/2	9 3/8	10 1/2	12	15	17 3/4	25 3/8	29 3/4	34	39	40 3/8	62
	300# FLGD	8 3/4	9 7/8	11 1/8	12 3/4	15 5/8	18 5/8	26 3/8	31 1/8	35 1/2	40 1/2	42	63 3/4
B	SCREWED	1 7/16	1 11/16	1 7/8	2 1/4	--	--	--	--	--	--	--	--
	GROOVED	1*	1 3/16	1 7/16	1 3/4	2 1/4	3 5/16	--	--	--	--	--	--
	150# FLGD	2 5/16-2 1/2	3	3 1/2	3 3/4	4 1/2	5 1/2	6 3/4	8	9 1/2	10 5/8	11 3/4	16
	300# FLGD	2 5/8-3 1/16	3 1/4	3 3/4	4 1/8	5	6 1/4	7 1/2	8 3/4	10 1/4	11 1/2	12 3/4	18
C	SCREWED	4 3/8	4 3/4	6	6 1/2	--	--	--	--	--	--	--	--
	GROOVED	4 3/8*	4 3/4	6	6 1/2	7 5/8	--	--	--	--	--	--	--
	150# FLGD	4 1/4	4 3/4	6	6	7 1/2	10	12 11/16	14 7/8	17	--	20 13/16	--
ANGLE	300# FLGD	4 3/8	5	6 3/8	6 3/8	7 13/16	10 1/2	13 3/16	15 9/16	17 3/4	--	21 5/8	--
	SCREWED	3 1/8	3 7/8	4	4 1/2	--	--	--	--	--	--	--	--
	GROOVED	3 1/8*	3 7/8	4	4 1/2	5 5/8	--	--	--	--	--	--	--
D	150# FLGD	3	3 7/8	4	4	5 1/2	6	8	11 3/8	11	--	15 11/16	--
	300# FLGD	3 1/8	4 1/8	4 3/8	4 3/8	5 13/16	6 1/2	8 1/2	12 1/16	11 3/4	--	16 1/2	--
	ALL	6	6	7	6 1/2	8	10	11 7/8	15 3/8	17	18	19	27
F	ALL	3 7/8	3 7/8	3 7/8	3 7/8	3 7/8	3 7/8	6 3/8	6 3/8	6 3/8	6 3/8	6 3/8	8
G	ALL	6	6 3/4	7 11/16	8 3/4	11 3/4	14	21	24 1/2	28	31 1/4	34 1/2	52
H	ALL	10	11	11	11	12	13	14	17	18	20	20	28 1/2

*GROOVED END NOT AVAILABLE IN 1 1/4"

METRIC DIMENSIONS - M.M.

DIM	END CONN.	DN32-DN40	DN50	DN65	DN80	DN100	DN150	DN200	DN250	DN300	DN350	DN400	DN600
A	SCREWED	222	251	267	330	--	--	--	--	--	--	--	--
	GROOVED	222	251	267	330	387	508	--	--	--	--	--	--
	150# FLGD	216	238	267	305	381	451	645	756	864	991	1026	1575
	300# FLGD	222	251	283	324	397	473	670	791	902	1029	1067	1619
B	SCREWED	37	43	48	57	--	--	--	--	--	--	--	--
	GROOVED	25*	30	37	44	57	84	--	--	--	--	--	--
	150# FLGD	59-64	76	89	95	114	140	171	203	241	270	298	406
	300# FLGD	67-78	83	95	105	127	159	191	222	260	292	324	457
C	SCREWED	111	121	152	165	--	--	--	--	--	--	--	--
	GROOVED	111*	121	152	165	194	--	--	--	--	--	--	--
	150# FLGD	108	121	152	152	191	254	322	378	432	--	529	--
ANGLE	300# FLGD	111	127	162	162	198	267	335	395	451	--	549	--
	SCREWED	79	98	102	114	--	--	--	--	--	--	--	--
	GROOVED	79*	98	102	114	143	--	--	--	--	--	--	--
D	150# FLGD	76	98	102	102	140	152	203	289	279	--	398	--
	300# FLGD	79	105	111	111	148	165	216	306	298	--	419	--
	ALL	152	152	178	165	203	254	302	391	432	457	483	686
F	ALL	98	98	98	98	98	98	162	162	162	162	162	203
G	ALL	152	171	195	222	298	356	533	622	711	794	876	1321
H	ALL	254	279	279	279	305	330	356	432	457	508	508	724

*GROOVED END NOT AVAILABLE IN DN32

For maximum efficiency, the OCV control valve should be mounted in a piping system so that the valve bonnet (cover) is in the top position. Other positions are acceptable but may not allow the valve to function to its fullest and safest potential. In particular, please consult the factory before installing 8" and larger valves, or any valves with a limit switch, in positions other than described. Space should be taken into consideration when mounting valves and their pilot systems.

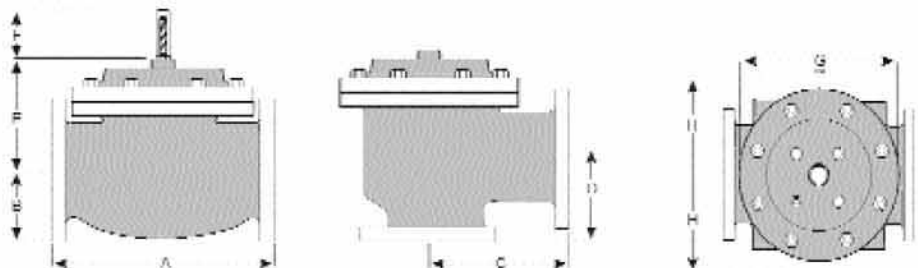

A routine inspection & maintenance program should be established and conducted yearly by a qualified technician. Consult our factory @ **1-888-628-8258** for parts and service.

How to order your valve

When Ordering please provide:
 Series Number - Valve size - Globe or Angle -
 Pressure Class - Screwed, Flanged, Grooved -
 Trim Material - Adjustment Range - Pilot
 Options - Special needs / or installation requirements.

Represented by:

TOLL FREE 1.888.628.8258 • phone: (918)627.1942 • fax: (918)622.8916 • 7400 East 42nd Place, Tulsa, Ok 74145
 email: sales@controlvalves.com • website: www.controlvalves.com