

## DE\RC

Electrically Actuated, Remote Reset Deluge Valve  
3/2 Solenoid

Also available with manual reset DE\RC-MR.

Electrically controlled deluge/pre-action valve, actuated by the pipeline pressure. The valve is closed in its normal, set position and opens when a 3w solenoid valve is energized. It closes drip tight when the solenoid valve is de-energized. An emergency manual release valve is fitted as standard.

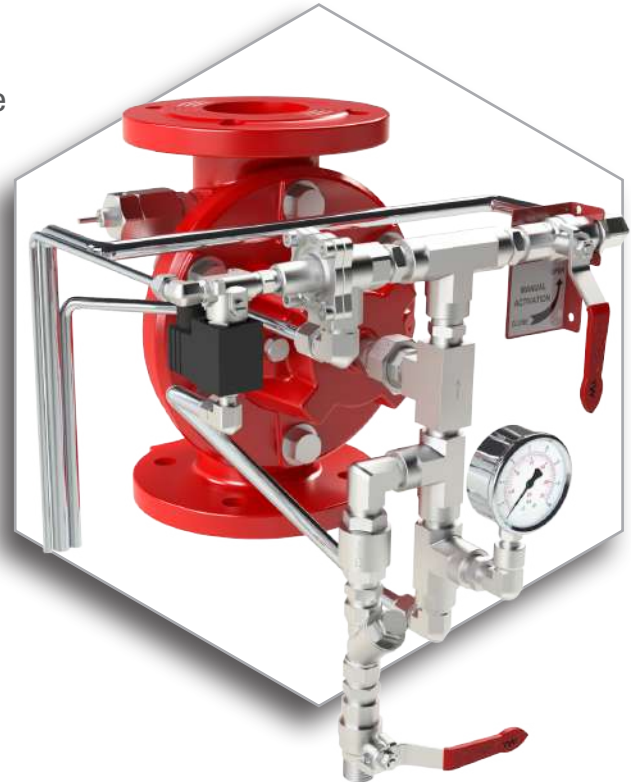

\* General representation of valve

### CERTIFICATION & COMPLIANCE



- ANSI FCI 70-2 Class VI seat leakage class
- UL listed under VLFT category
- Fire tested to EN ISO 6182-5:2006 (2" - 6" only)
- Lloyd's & ABS approvals

### FEATURES & BENEFITS

- |   |  |
|---|--|
| <ul style="list-style-type: none"> <li>• High pressure (PN25/375psi), high flow deluge systems</li> <li>• Automatic or local manual emergency actuation</li> <li>• Hazardous, flammable &amp; explosion classified area fire suppression</li> <li>• Superior design featuring exceptionally low pressure losses at high flow rates</li> </ul> | <ul style="list-style-type: none"> <li>• Low lifelong maintenance costs due to straightforward design</li> <li>• Applicable for fresh or brackish water, seawater &amp; foam</li> <li>• Out of box fully assembled &amp; tested valves</li> <li>• Factory trimmed for vertical &amp; horizontal installations without modification</li> <li>• Extensive valve &amp; trim materials selection and corrosion protection coating</li> </ul> |
|---|--|

### TYPICAL APPLICATIONS



Automatic or Manual Actuated Fire Suppression Systems



Petrochemical, Oil & Gas Installations



Tunnels



Power Generation, Transformer & Transmission Plants



Flammable Storage



Hangars & Airport Terminals



Onshore / Offshore



Mining

OPERATION

The basic control valve [1] used in this deluge system is a direct sealing elastomeric diaphragm, hydraulically operated control valve engineered specifically for fire protection systems. The system includes a 3/2-way N.O. solenoid [10] as the interface between the fire alarm control panel - monitoring heat, smoke or flames - and the deluge valve.

In the standby position, the deluge valve is held closed by the upstream water pressure, trapped in the valve's control chamber. The water pressure enters the control chamber through the priming line ball valve [2], a Y-type strainer [3], a check valve [4] and a T-restrictor [5].

Under fire conditions, a fire alarm control panel energizes the 3/2-way N.O. solenoid (or de-energizes the coil of a continuously energized ED 100% normally closed solenoid for SIL 3-4 rated systems). The pressure in the relay valve [9] drops, causing it to open and allowing the water to drain from the deluge valve's control chamber. The deluge valve opens instantly and allows water to flow into the pipeline and through the open sprinklers over the protected area.

Manual emergency actuation is enabled by opening the emergency manual activation valve [6]. The deluge valve opens instantly and allows water to flow into the pipeline and through the open sprinklers over the protected area.

Standby Position

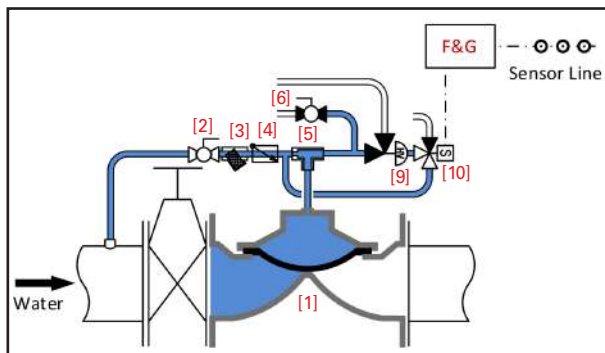

Electrically Actuated

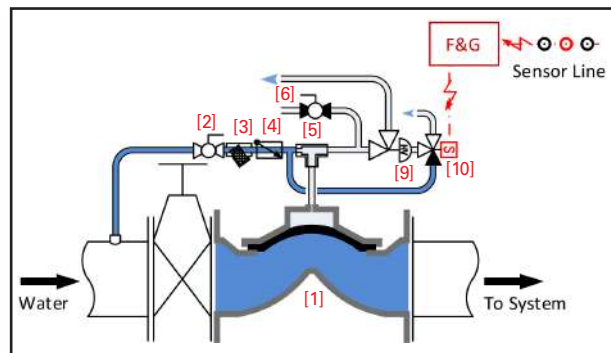

Manually Actuated

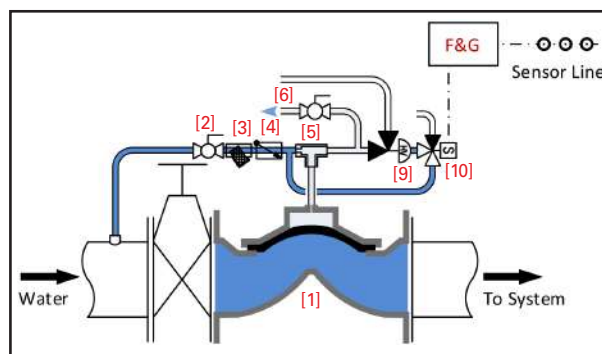

Resetting, maintenance and periodic testing instructions must be followed as described in detail in the applicable OCV IOM (Installation, Operation & Maintenance) Manual.

TYPICAL MATERIALS

ID	Description	Standard	POG <sup>(1)</sup> Applications
1	Valve Body	See Series 100 Engineering Data <sup>(2)</sup>	
2	Ball Valve	Bronze, Stainless Steel Ball	Stainless Steel 316
3	Y-Type Strainer	Bronze, Stainless Steel Screen	Stainless Steel 316
4	Check Valve	Bronze	Stainless Steel 316
5	T Restrictor	Brass	Stainless Steel 316
6	Manual Emergency Valve	Bronze	Stainless Steel 316
7	Drip Valve	Brass	Stainless Steel 316
8	Pressure Gauge	Stainless Steel	Stainless Steel 316
9	28-200 Relay	Brass	Stainless Steel 316
10	3/2 Way N.O. Solenoid <sup>(3)</sup>	Brass	Stainless Steel 316

(1) Petrochemical, Oil & Gas

(2) Refer to materials selection guidelines, Engineering Data - Materials: Ductile Iron A-536 65-45-12; Cast Steel A-216 WCB; Cast Steel A-352 LCB; Austenitic Stainless Steel A-351/CF8M; Super Duplex 2507; Nickel-Aluminum-Bronze B-148 UNS C95800

(3) Consult factory

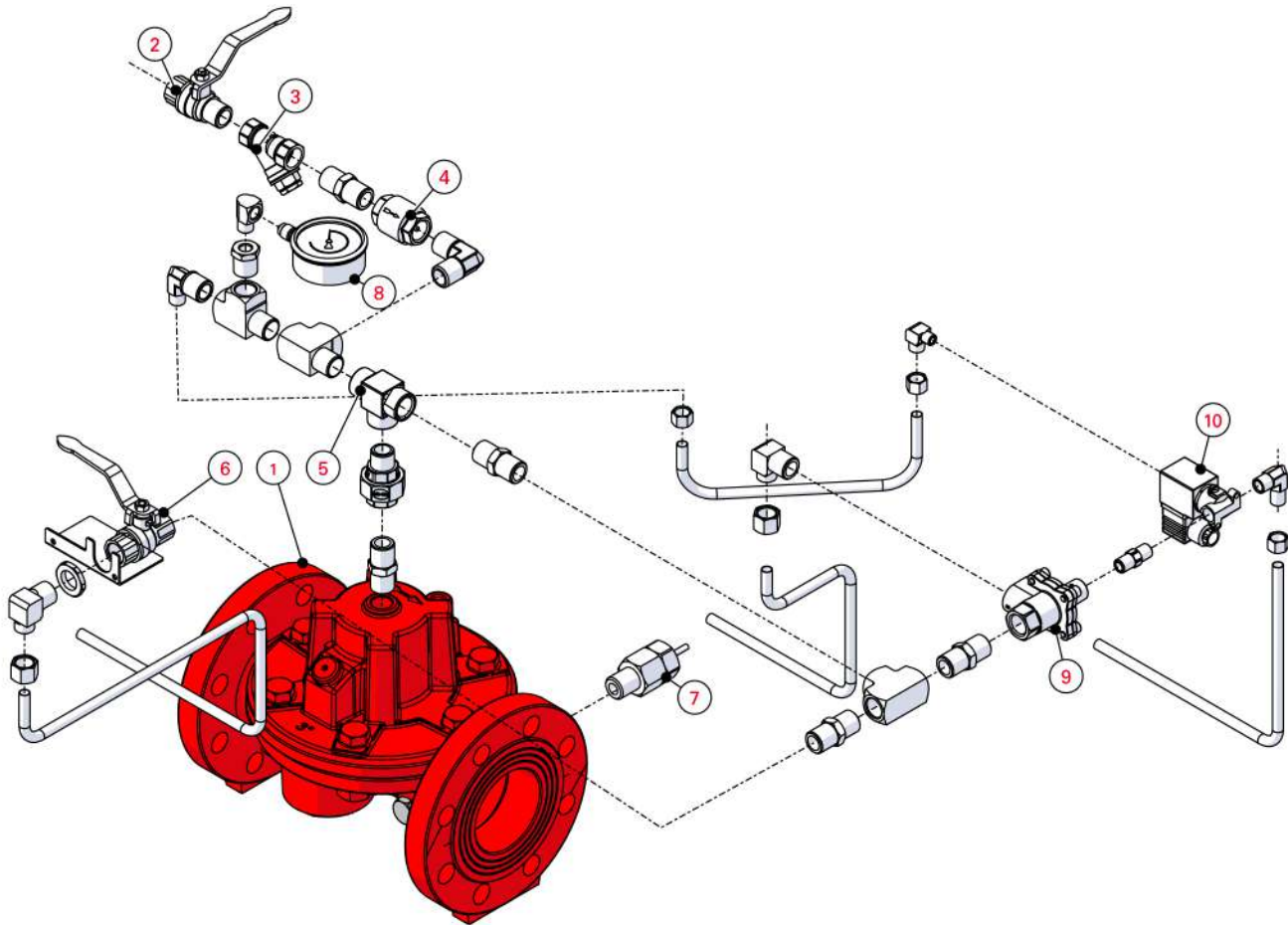

\* General representation of valve

**GENERAL ARRANGEMENT & DIMENSIONS**

Valve	2" (50)		2.5" (65)		3" (80)		4" (100)		6" (150)		8" (200)		10" (250)	
	inch	mm	inch	mm	inch	mm	inch	mm	inch	mm	inch	mm	inch	mm
A	9 5/8	243	9 3/16	233	12 3/16	310	14	356	17 3/16	436	20 7/8	530	25	635
A <sub>G</sub> <sup>(1)</sup>	9 5/8	243	10	253	13 3/16	336	15	380	17 5/16	440	21 7/8	556	N/A	
B	6 5/8	168	7 3/8	185	7 7/8	200	9 3/8	238	12 1/8	306	14 3/16	360	16 7/8	430
C	6 13/16	172	6 13/16	172	8 1/8	205	8 5/8	219	9 11/16	248	11 5/16	288	13 3/16	337
D	5 3/8	138	5 3/8	138	5 3/8	138	5 3/8	138	6 5/16	160	7 7/8	200	9 13/16	249
E	10 1/8	256	10 1/8	256	12 11/16	322	12 1/2	318	15 13/16	401	16 5/8	421	17 1/2	444
F	9 11/16	246	9 11/16	246	9 11/16	246	9 11/16	246	9 11/16	246	10 3/8	265	12 1/2	317

\* Approximate dimensions

\*\* (1) Grooved model length

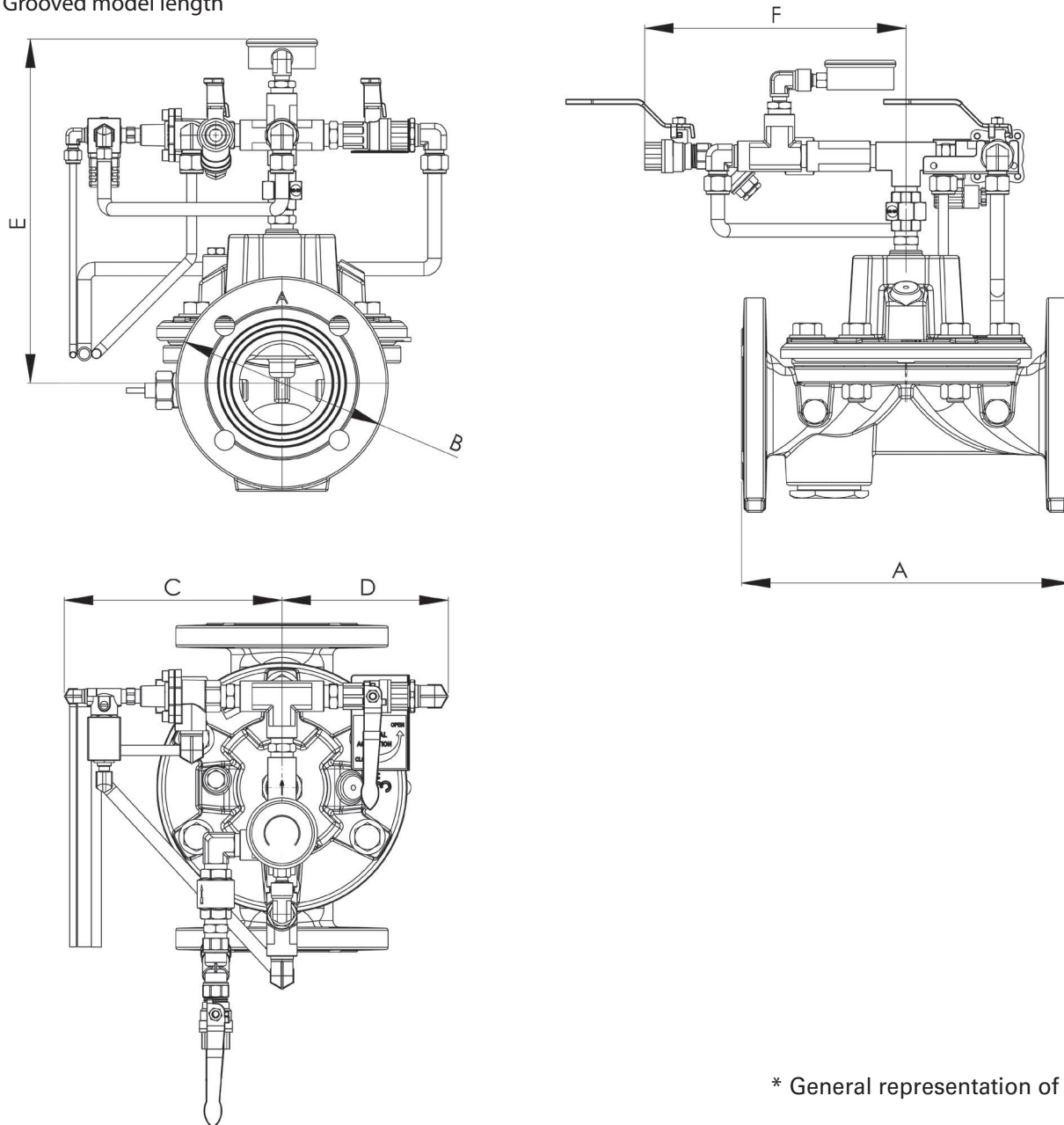

\* General representation of valve

TYPICAL INSTALLATION

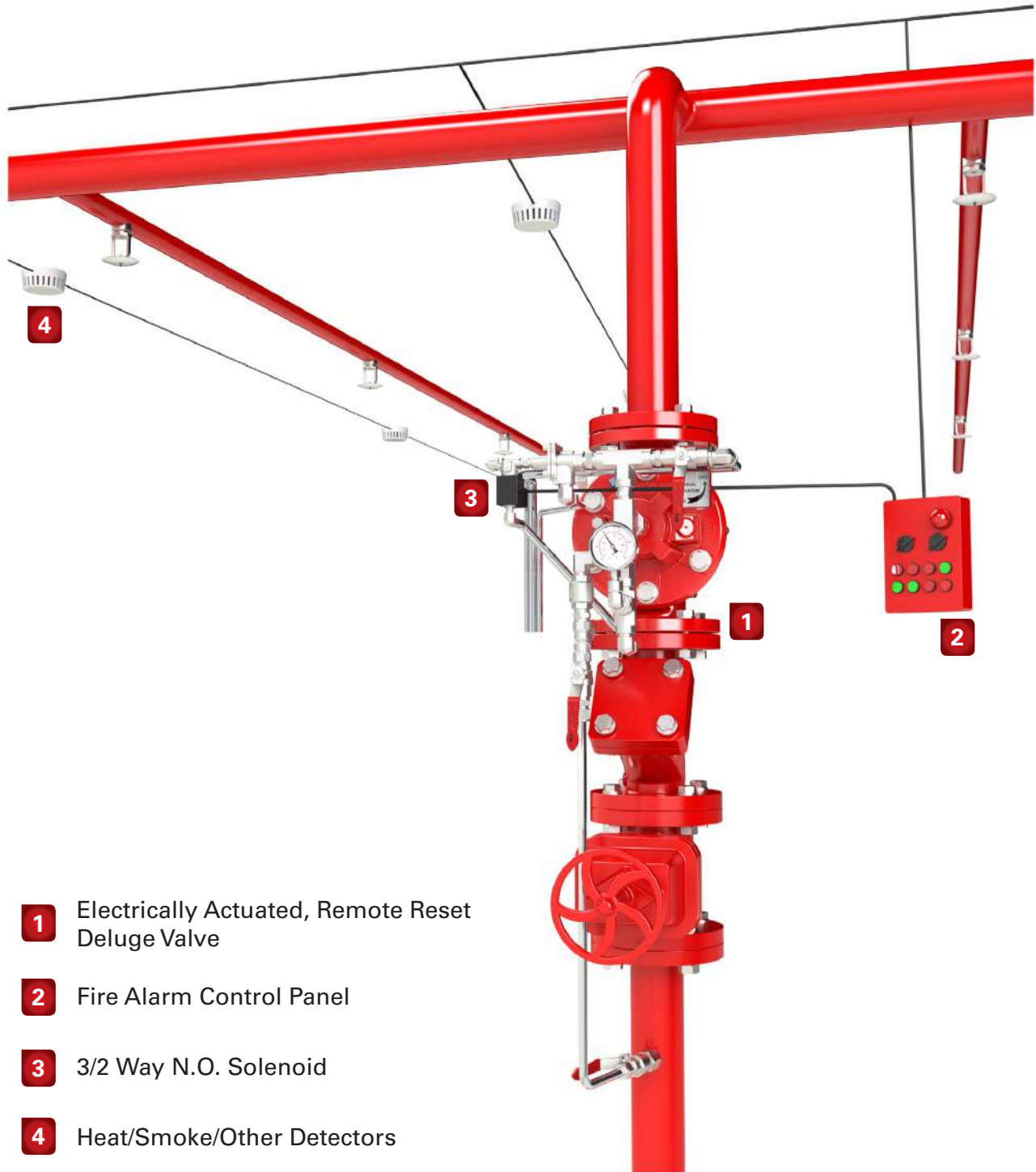

- 1** Electrically Actuated, Remote Reset Deluge Valve
- 2** Fire Alarm Control Panel
- 3** 3/2 Way N.O. Solenoid
- 4** Heat/Smoke/Other Detectors

\* Not all items pictured reflect products sold by OCV

## TECHNICAL DATA

### Temperature:

- Media up to 80°C = 176°F
- Elastomers suitable for extreme climates available upon request

### Sizes:

- UL Listed Sizes: Model 68: 2"-10"
- Straight Flow: 2"- 24"

### End Connections:

- Flanged:  
ISO-PN16 & ISO-PN25  
ANSI B16.42 & B16.5 Class #150 and #300  
Additional options available upon request
- Grooved:  
Sizes: 2"-8"

### Pressure Rating:

- 250 psi for Class #150
- 375 psi for Class #300

### Body and Cover Material:

- Ductile Iron
- Cast Steel
- Stainless Steel
- NAB

### Trim Material:

- Bronze/Brass - Copper
- Stainless Steel
- Monel

### Optional Components:

- Spring
- Position Indicator
- Pressure Switch
- Alarm Test Trim
- Upstream Drain Valve
- Limit/Proximity Switch

### Items to Specify:

- Electrical features other than standard (24VDC, IP65/NEMA4)
- If explosion proof accessories are required such as solenoids, pressure switches, etc., please define classification
- Control trim material other than standard
- Required standards, certifications and approvals

## ENGINEERING SPECIFICATIONS

The deluge valve shall be hydraulically operated, direct elastomeric diaphragm-seal, single chamber weir type. The valve shall consist of three major components: the body, the cover and the diaphragm assembly. The diaphragm assembly shall be the only moving part. The diaphragm forms a sealed control chamber in the upper portion of the valve, separating operating pressure from line pressure. Packing glands, stuffing boxes and dynamic O-ring seals are not permitted and there shall not be shafts, discs, bearings or pistons operating the valve. No hourglass shaped disc retainers shall be permitted, and no V-type, U-type or other slotted type disc guides shall be used. The valve shall contain a nylon reinforced rubber diaphragm, elastic & resilient through its entire surface without vulcanized radial seals and/or reinforcements. The diaphragm assembly shall not be guided by any shafts or bearings and shall not be in close contact with other valve parts except for its sealing surface. The deluge valve shall be fully trimmed, hydrostatically and operationally tested at the factory. Maintenance, disassembly and reassembly of all the valve's components shall be made possible on-site and in-line, without the need to remove the valve from the line. Main valve body and bonnet standard material shall be Ductile Iron or Cast Steel. Main valve body and bonnet surfaces shall include a fire red epoxy coating. Other materials and coatings available upon request. The deluge valve shall be a Model 68 DE\RC, UL Listed under VLFT category, as manufactured by OCV Fluid Solutions, Tulsa, OK, USA.

OCV companies worldwide reserve the right to make changes without notice including product specification and configuration, content, description(s), dimensions etc. The information herein is subject to change without notice. OCV shall not be held liable for any errors. All rights reserved. © Copyright by OCV.